

IPC-PD49225T-W

2MP 25x Starlight IR PTZ Network Camera



System Overview

Featuring with powerful optical zoom and accurate pan/tilt/zoom performance, the IPC-PD49225T-W PTZ camera can provide large monitoring range and great detail. The camera delivers 1080P resolution at 50/60 fps, with 25x optical zoom, and has very excellent low light performance due to adopting the latest starlight technology. The IPC-PD49225T-W PTZ is equipped with smooth control, high quality image and good protection, which make it can meet small and medium size of video surveillance applications.

- 1/2.8" 2Megapixel STARVIS™ CMOS
- Powerful 25x optical zoom
- Starlight technology
- Support H.265&H.264 Triple-streams encoding
- Max. 50/60fps@1080P, 25/30/50/60fps@720P
- IVS
- Support PoE+
- IR distance up to 100m
- IP66



IPC-PD49225T-W

2MP 25x Starlight IR PTZ Network Camera

Functions

Starlight Technology

Thanks to the experience and expertise in hardware and software development, the camera is equipped with the latest image processing algorithm, high performance hardware and high quality optical components, which make the camera have very excellent low light performance. In most conditions, this camera can deliver clear, bright and low-noise color images.

High Efficiency Video Coding (H.265)

The H.265 (ITU-T VCEG) video compression standard offers double the data compression ratio at the same level of video quality, or substantially improved video quality at the same bit rate, as compared to older video compression technologies. H.265 offers such impressive compression by expanding the pattern comparison and difference-coding, improving motion vector prediction and motion region merging, and incorporating an additional filtering step called sample-adaptive offset filtering.

Wide Dynamic Range

Embedded with industry leading wide dynamic range (WDR) technology, vivid pictures are achieved even in the most intense contrast lighting conditions. For applications with both bright and low lighting conditions that change quickly, true WDR (120dB) optimizes both the bright and dark areas of a scene at the same time to provide usable video.

Environmental

With a temperature range of -40 °C to +70 °C (-40 °F to +158 °F), the camera is designed for extreme temperature environments. Subjected and certified to rigorous dust and water immersion tests, the IP66 rating makes it suitable for demanding outdoor applications.

Protection

This camera suits even the harsh conditions for outdoor applications. Its 6KV lightning rating provides protection against the camera and its structure from the effects of lightning.

Interoperability

The camera conforms to the ONVIF (Open Network Video Interface Forum) and PSIA (Physical Security Interoperability Alliance) specifications, ensuring interoperability between network video products regardless of manufacturer.

Technical Specification

Camera

Image Sensor	1/2.8" STARVIS™ CMOS
Effective Pixels	1920(H) x 1080(V), 2 Megapixels
RAM/ROM	1024M/128M
Scanning System	Progressive
Electronic Shutter Speed	1/1s~1/300,000s
Minimum Illumination	Color: 0.005Lux@F1.6; 0Lux@F1.6 (IR on)
S/N Ratio	More than 50dB
IR Distance	Distance up to 100m (328ft)
IR On/Off Control	Auto/Manual
IR LEDs	6

Lens

Focal Length	4.8mm~120mm
Max. Aperture	F1.6 ~ F4.4
Angle of View	H: 59.2° ~ 2.4°
Optical Zoom	25x
Focus Control	Auto/Manual
Close Focus Distance	100mm~ 1000mm

DORI Distance

*Note: The DORI distance is a "general proximity" of distance which makes it easy to pinpoint the right camera for your needs. The DORI distance is calculated based on sensor specification and lab test result according to EN 62676-4 which defines the criteria for Detect, Observe, Recognize and Identify respectively.

Detect	Observe	Recognize	Identify
1613m(5292ft)	646m(2119ft)	323m(1060ft)	161m(528ft)

PTZ

Pan/Tilt Range	Pan: 0° ~ 360° endless; Tilt: -15° ~ 90°, auto flip 180°
Manual Control Speed	Pan: 0.1° ~200° /s; Tilt: 0.1° ~120° /s
Preset Speed	Pan: 240° /s; Tilt: 200° /s
Presets	300
PTZ Mode	5 Pattern, 8 Tour, Auto Pan ,Auto Scan
Speed Setup	Human-oriented focal Length/ speed adaptation
Power up Action	Auto restore to previous PTZ and lens status after power failure
Idle Motion	Activate Preset/ Scan/ Tour/ Pattern if there is no command in the specified period
Protocol	DH-SD

Intelligence

Auto Tracking	N/A
IVS	Tripwire, Intrusion, Abandoned/Missing, Face Detection

Video

Compression	H.265/H.264 / MJPEG	
Streaming Capability	3 Streams	
Resolution	1080P(1920×1080)/720P(1280×720)/D1(704×576/704×480)/CIF(352×288/352×240)	
Frame Rate	Main stream	1080P/720P/D1(1~50/60fps)
	Sub stream1	D1/CIF(1 ~ 25/30fps)
	Sub stream2	1080P/720P/D1/ CIF (1 ~ 25/30fps)
Bit Rate Control	CBR/VBR	
Bit Rate	H.265/H.264: 448K ~ 8192Kbps, MJPEG: 5120K ~ 10240Kbps	
Day/Night	Auto(ICR) / Color / B/W	
Backlight Compensation	BLC / HLC / WDR(120dB)	
White Balance	Auto,ATW,Indoor,Outdoor,Manual	
Gain Control	Auto / Manual	
Noise Reduction	Ultra DNR (2D/3D)	
Motion Detetion	Support	
Region of Interest	Support	
Electronic Image Stabilization (EIS)	N/A	
Defog	Support	
Digital Zoom	16x	
Flip	180°	
Privacy Masking	Up to 24 areas	

Audio

Compression	G.711a/G.711u(32kbps)/PCM(128kbps)
-------------	------------------------------------

Network

Ethernet	RJ-45 (10/100Base-T)
Protocol	IPv4/IPv6,HTTP,HTTPS,SSL,TCP/IP, UDP,UPnP, ICMP,IGMP,SNMP,RTSP,RTP, SMTP, NTP,DHCP, DNS,PPPOE,DDNS,FTP, IP Filter,QoS,Bonjour,802.1x
Interoperability	ONVIF, PSIA, CGI
Streaming Method	Unicast / Multicast
Max. User Access	20 users
Edge Storage	NAS (Network Attached Storage),Local PC for instant recording, Micro SD card 128GB
Web Viewer	IE, Chrome, Firefox, Safari
Management Software	Smart PSS, DSS
Smart Phone	IOS, Android

Certifications

Certifications	CE: EN55032/EN55024/EN50130-4 FCC: Part15 subpartB,ANSI C63.4- 2014 UL: UL60950-1+CAN/CSA C22.2.No.60950-1
----------------	--

Interface

Video Interface	N/A
Audio Interface	1/1

IPC-PD49225T-W

2MP 25x Starlight IR PTZ Network Camera

RS485	N/A
Alarm	2/1
Electrical	
Power Supply	DC 12V/3A, PoE+(802.3at)
Power Consumption	13W,20W (IR on)
Environmental	
Operating Conditions	-40°C ~ 70°C (-40°F ~ +158°F) / Less than 90% RH
Ingress Protection	IP66
Vandal Resistance	N/A
Construction	
Casing	Metal
Dimensions	Φ160(mm) x 295(mm)
Net Weight	4kg(8.82lb)
Gross Weight	4.2kg(9.26lb)

Dimensions (mm)

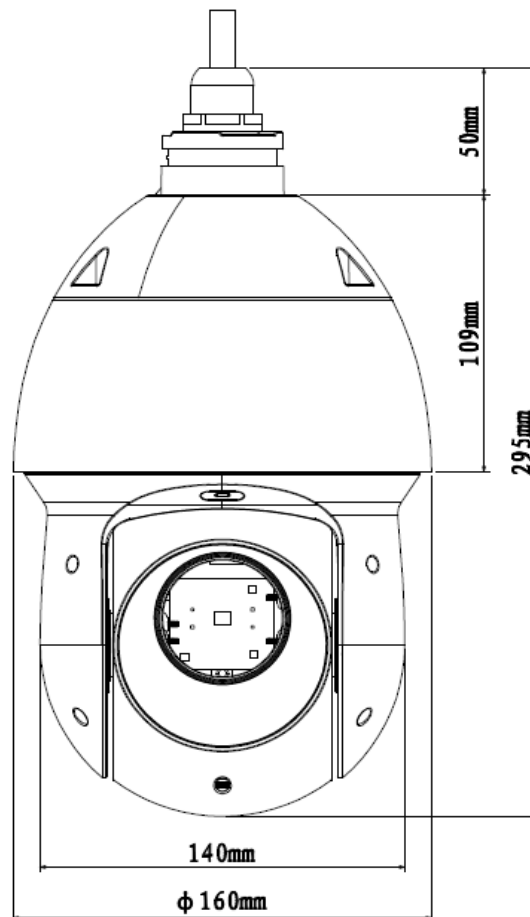

IPC-PD49225T-W

2MP 25x Starlight IR PTZ Network Camera

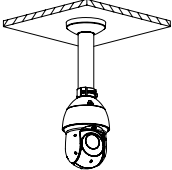
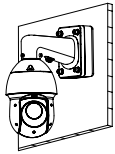
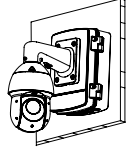
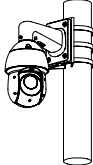
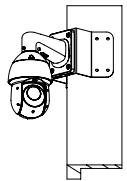
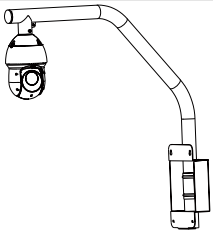
Ceiling Mount	Junction Mount
PFA111 + PFB300C	PFB305W + PFA120
	
Power Box Mount	Pole Mount
PFB305W + PFA140	PFB305W + PFA150
	
Corner Mount	Parapet Mount
PFB305W + PFA151	PFA111+ PFB303S
	

Accessories

Included:



PFB305W
Wall Mount

Optional :



PFA111
Mount Adapter



DC12V/3A
Power Supply



PFA140
Power box



PFB300C
Ceiling Mount



PFA120
Junction Box



PFA150
Pole Mount



PFA151
Corner Mount



PFB303S
Parapet Mount