

## AC318-OD

### 8 MP Dome Camera



#### Key Features

- 8.29 MP high performance CMOS
- 3840 × 2160 resolution
- 2.8 mm, 3.6 mm fixed lens
- EXIR 2.0, smart IR, up to 30 m IR distance
- 4 in 1 video output (switchable TVI/AHD/CVI/CVBS)
- IP67, IK10
- Up the coax (UTC-C)

# AC318-OD

## 8 MP Dome Camera

### Specification

<b>Camera</b>	
Image Sensor	8.29 megapixel progressive scan CMOS
Signal System	PAL/NTSC
Frame Rate	TVI: 8MP@12.5fps, 8MP@15fps, 5MP@20fps, 4MP@25fps, 4MP@30fps, 2MP@25fps, 2MP@30fps CVI: 8MP@12.5fps, 8MP@15fps AHD: 5MP@20fps CVBS: 960H P/N
Resolution	3840 (H) × 2160 (V)
Min. Illumination	Color: 0.01 Lux@(F1.2, AGC ON), 0 Lux with IR
Shutter Time	PAL: 1/12.5 s to 1/50,000 s NTSC: 1/15 s to 1/50,000 s
Lens	2.8 mm, 3.6 mm fixed lens
Horizontal Field of View	102.2° (2.8 mm), 79° (3.6 mm)
Lens Mount	M16
Day & Night	IR cut filter
Angle Adjustment (Bracket)	Pan: 0° to 355°, Tilt: 0° to 75°, Rotate: 0° to 355°
Synchronization	Internal synchronization
DWDR (Digital Wide Dynamic Range)	105 dB
<b>Menu</b>	
AGC	Yes
Day/Night Mode	Auto/Color/BW (Black and White)
White Balance	Auto/Manual
BLC (Backlight Compensation)	Yes
Language	English
Functions	Brightness, Sharpness, DNR, Mirror, Smart IR
<b>Interface</b>	
Video Output	1 HD analog output
Switch Button	TVI/AHD/CVI/CVBS
<b>General</b>	
Operating Conditions	-40 °C to 60 °C (-40 °F to 140 °F), humidity: 90% or less (non-condensation)
Power Supply	12 VDC ±25%
Power Consumption	Max. 5.3 W
Protection Level	IP67, IK10
Material	Metal
IR Range	Up to 30 m
Communication	Up the coax, Protocol: UTC-C (TVI output)
Dimensions	∅ 111 mm × 82.4 mm (∅ 4.4" × 3.2" )
Weight	Approx. 495 g (1.09 lb.)

# AC318-OD

## 8 MP Dome Camera

### Dimension

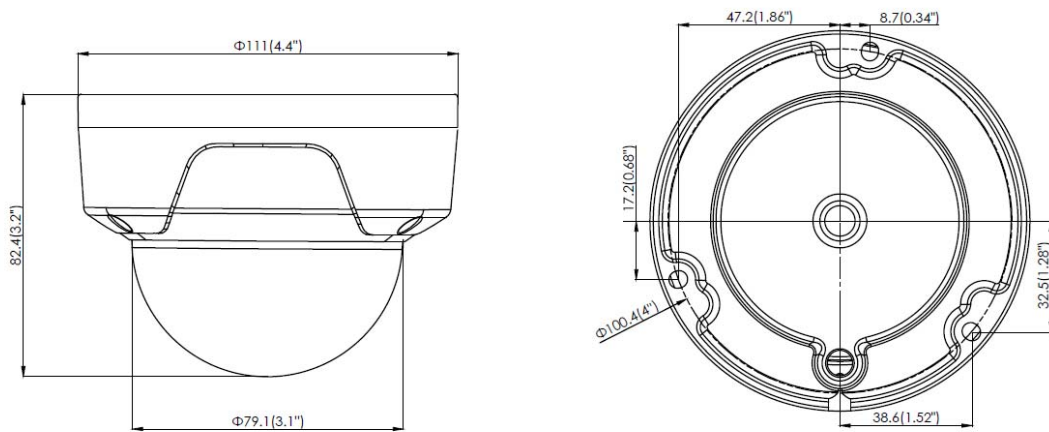

### Accessory

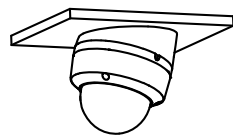

1259ZJ  
Inclined Ceiling Mount

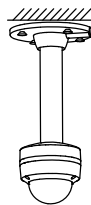

1271ZJ-110  
Pendant Mount

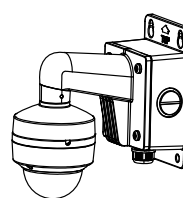

1272ZJ-110B  
Wall Mount



1272ZJ-110  
Wall Mount

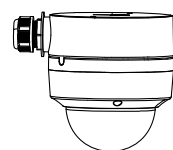

1280ZJ-DM18  
Junction Box

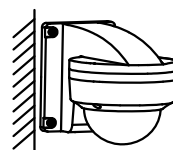

1258ZJ  
Wall Mount

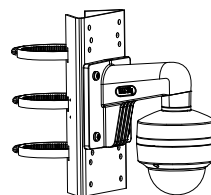

1275ZJ-SUS  
Vertical Pole Mount